

## X-CREATE COMPONENTS FLYER

## 2025 X-CREATE COMPONENTS

### UPRIGHT COMPONENT 1



**Product Code:** XCREATE-UC1

### DESCRIPTION

- 3" x 5" 11 gauge construction provides a solid structure for all X-Create systems
- High Gloss Platinum II or Satin Black powder coat finish
- One of 2 components needed to construct a 7 foot, 8 foot or 2 sided 8 foot X-CREATE upright

### COMPATIBILITY

X-Create	√
X-Rack	
X-Siege	
TR-1	
TR-2	

### UPRIGHT COMPONENT 2, 7 FOOT (2.1 M) SINGLE-SIDED

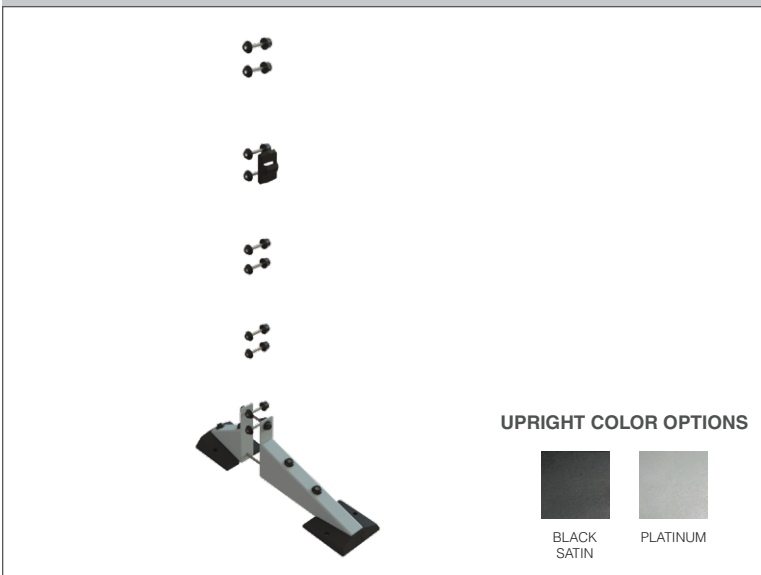

**Product Code:** XCREATE-UC2-7SS

### DESCRIPTION

- High Gloss Platinum II or Satin Black powder coat finish
- Includes rubber molded feet, bolt and nut covers, and magnetic suspension clip
- Compatible with XCREATE-UC1 to create a 7 foot single sided upright

### COMPATIBILITY

X-Create	√
X-Rack	
X-Siege	
TR-1	
TR-2	

## 2025 X-CREATE COMPONENTS

### UPRIGHT COMPONENT 2, 8 FT (2.4 M) SINGLE-SIDED

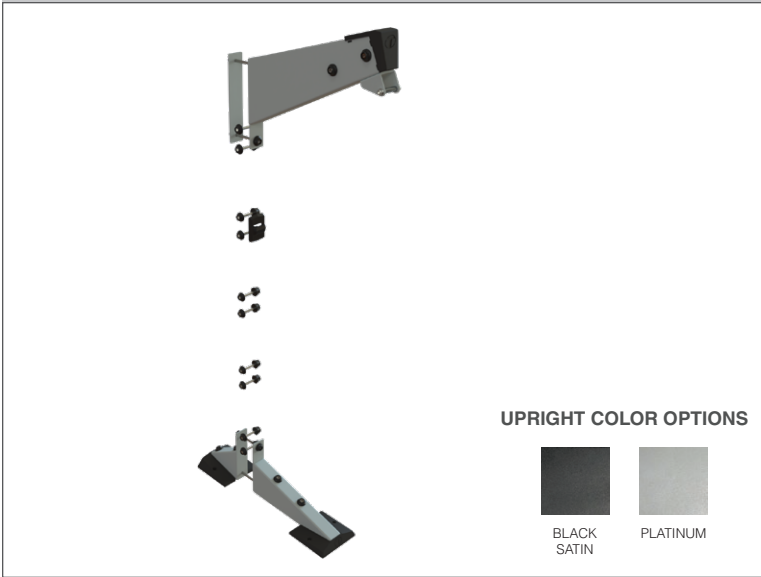

**Product Code:** XCREATE-UC2-8SS

#### DESCRIPTION

- High Gloss Platinum II or Satin Black powder coat finish
- Includes rubber molded feet, bolt and nut covers, and magnetic suspension clip
- Compatible with XCREATE-UC1 to create an 8 foot single sided upright

#### COMPATIBILITY

X-Create	√
X-Rack	
X-Siege	
TR-1	
TR-2	

### UPRIGHT COMPONENT 2, 8 FT (2.4 M) SINGLE-SIDED LONG BASE

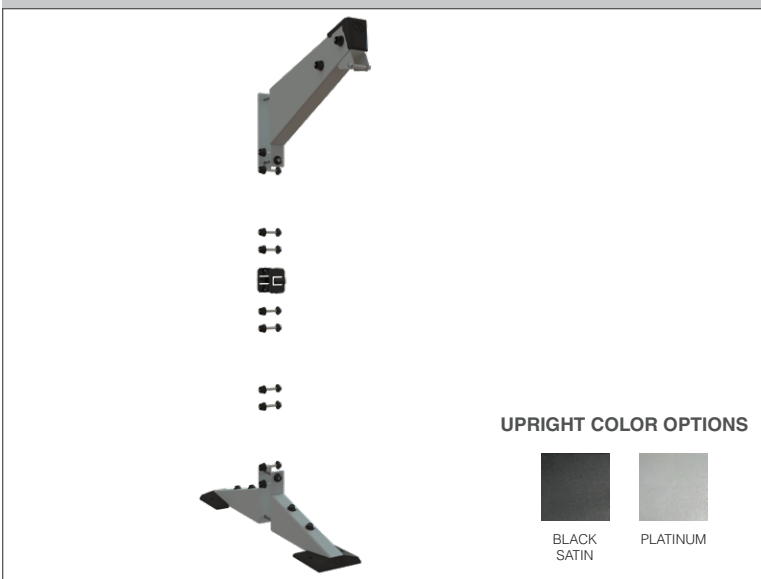

**Product Code:** XCREATE-UC2-8SSLB

#### DESCRIPTION

- High Gloss Platinum II or Satin Black powder coat finish
- Includes rubber molded feet, bolt and nut covers, and magnetic suspension clip
- Compatible with XCREATE-UC1 to create an 8 foot single sided upright

#### COMPATIBILITY

X-Create	√
X-Rack	
X-Siege	
TR-1	
TR-2	

## 2025 X-CREATE COMPONENTS

### UPRIGHT COMPONENT 2, 7 FT (2.1 M) SINGLE-SIDED SHORT BASE

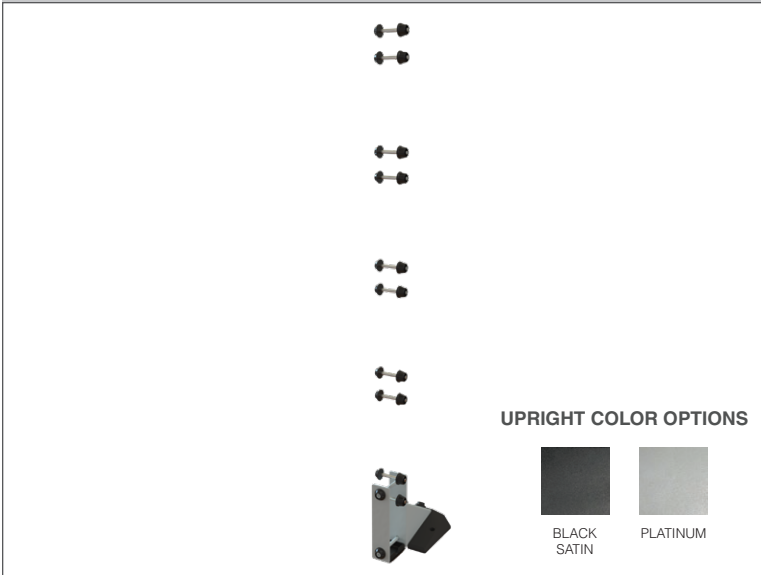

**Product Code:** XCREATE-UC2-7SSSB

#### DESCRIPTION

- High Gloss Platinum II or Satin Black powder coat finish
- Includes rubber molded feet, bolt and nut covers
- Compatible with XCREATE-UC1 in X-CREATE Corner Units as well as XCREATE-UCC

#### COMPATIBILITY

X-Create	√
X-Rack	
X-Siege	
TR-1	
TR-2	

### UPRIGHT COMPONENT 2, SINGLE-SIDED CABLE CONENT/SINGLE SIDED

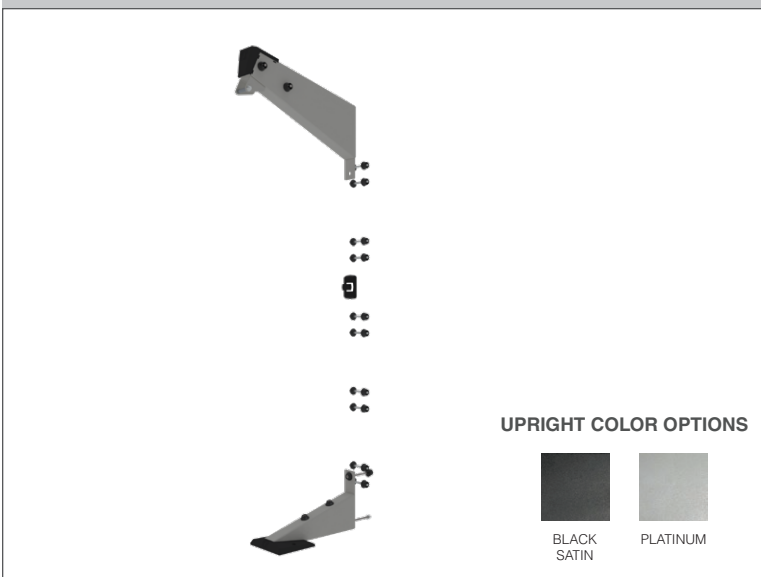

**Product Code:** XCREATE-UC2-8SSCC-SS

#### DESCRIPTION

- High Gloss Platinum II or Satin Black powder coat finish
- Includes rubber molded feet, bolt and nut covers, and magnetic suspension clip
- Compatible with XCREATE-UC1 and XCREATE-UCC to create cable station uprights
- 8 Foot (2.4 Meter) height

#### COMPATIBILITY

X-Create	√
X-Rack	
X-Siege	
TR-1	
TR-2	

## 2025 X-CREATE COMPONENTS

### UPRIGHT COMPONENT 2, 8 FT (2.4 M) DUAL-SIDED

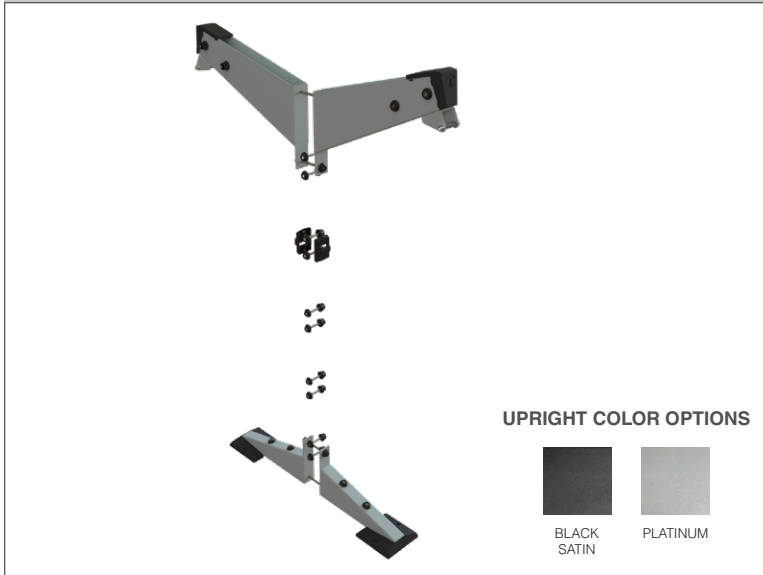

**Product Code:** XCREATE-UC2-8DS

### DESCRIPTION

- High Gloss Platinum II or Satin Black powder coat finish
- Includes rubber molded feet, bolt and nut covers, and magnetic suspension clip
- Compatible with XCREATE-UC1 to create an 8 foot double-sided upright

### COMPATIBILITY

X-Create	√
X-Rack	
X-Siege	
TR-1	
TR-2	

### 4 FT (1.2 M) STORAGE RACK SIDE



**Product Code:** XCREATE-4SRS

### DESCRIPTION

- 3" x 5" 11 gauge construction provides a solid structure for X-CREATE systems and storage racks
- High Gloss Platinum II or Satin Black powder coat finish
- Includes rubber molded feet

### COMPATIBILITY

X-Create	√
X-Rack	
X-Siege	
TR-1	
TR-2	

## 2025 X-CREATE COMPONENTS

### 5 FT (1.5 M) UPRIGHT



**Product Code: XCREATE-5U**

#### DESCRIPTION

- 3" x 5" 11 gauge construction provides a solid structure for X-CREATE systems and storage racks
- High Gloss Platinum II or Satin Black powder coat finish
- Includes rubber molded feet

#### COMPATIBILITY

X-Create	√
X-Rack	
X-Siege	
TR-1	
TR-2	

### 2-SIDED 5 FT (1.5M) UPRIGHT



**Product Code: XCREATE-2S5U**

#### DESCRIPTION

- 3" x 5" 11 gauge construction provides a solid structure for X-CREATE systems and storage racks
- High Gloss Platinum II or Satin Black powder coat finish
- Includes rubber molded feet

#### COMPATIBILITY

X-Create	√
X-Rack	
X-Siege	
TR-1	
TR-2	

## 2025 X-CREATE COMPONENTS

**4 FT (1.2 M) TRAY**



**Product Code: XCREATE-4TRAY**

### DESCRIPTION

- Over built to handle your heaviest accessories
- Can be mounted at an angle for ergonomic placement and retrieval of dumbbells
- Compatible with XCREATE-4MAT

### COMPATIBILITY

X-Create	√
X-Rack	√
X-Siege	
TR-1	
TR-2	

**4 FT (1.2 M) TRAY MAT**



**Product Code: XCREATE-4MAT**

### DESCRIPTION

- Over built to handle your heaviest accessories
- For use with XCREATE-4TRAY (qty 1) and XCREATE-8TRAY (qty 2)

### COMPATIBILITY

X-Create	√
X-Rack	√
X-Siege	
TR-1	√
TR-2	√

## 2025 X-CREATE COMPONENTS

### 6 FT (1.8 M) TRAY



**Product Code:** XCREATE-6TRAY

#### DESCRIPTION

- Over built to handle your heaviest accessories
- Can be mounted at an angle for ergonomic placement and retrieval of dumbbells
- Compatible with XCREATE-6MAT

#### COMPATIBILITY

X-Create	√
X-Rack	√
X-Siege	
TR-1	√
TR-2	√

### 6 FT (1.8 M) MAT



**Product Code:** XCREATE-6MAT

#### DESCRIPTION

- Over built to handle your heaviest accessories
- For use with XCREATE-6TRAY

#### COMPATIBILITY

X-Create	√
X-Rack	√
X-Siege	
TR-1	√
TR-2	√

## 2025 X-CREATE COMPONENTS

### 8 FT (2.4 M) TRAY



**Product Code:** XCREATE-8TRAY

#### DESCRIPTION

- Over built to handle your heaviest accessories
- Can be mounted at an angle for ergonomic placement and retrieval of dumbbells
- Compatible with XCREATE-4MAT (2)

#### COMPATIBILITY

X-Create	√
X-Rack	√
X-Siege	
TR-1	√
TR-2	√

### 4 FT (1.2 M) BALL STORAGE



**Product Code:** XCREATE-4BS

#### DESCRIPTION

- Minimalist rack for ball storage
- Fully welded and sized to accept any Torque Wall, Medicine or Slam Ball

#### COMPATIBILITY

X-Create	√
X-Rack	√
X-Siege	
TR-1	
TR-2	

## 2025 X-CREATE COMPONENTS

### 6 FT (1.8 M) BALL STORAGE



**Product Code:** XCREATE-6BS

#### DESCRIPTION

- Next generation ball storage requires no adjustment
- Compatible with Torque's smallest medicine and slam balls up to our larger diameter stability balls

#### COMPATIBILITY

X-Create	√
X-Rack	√
X-Siege	
TR-1	√
TR-2	√

### 6 FT (1.8 M) BALL & HANGING STORAGE



**Product Code:** XCREATE-6BHS

#### DESCRIPTION

- Rails designed to accommodate different diameter balls
- Adjustable curved pegs provide storage for exercise mats with holes spaced 15 in - 21.7 in (38 cm - 55 cm)
- Additional pegs to store various hanging accessories

#### COMPATIBILITY

X-Create	√
X-Rack	√
X-Siege	
TR-1	√
TR-2	√

## 2025 X-CREATE COMPONENTS

### 4 FT (1.2 M) BUMPER BOOKSHELF STORAGE

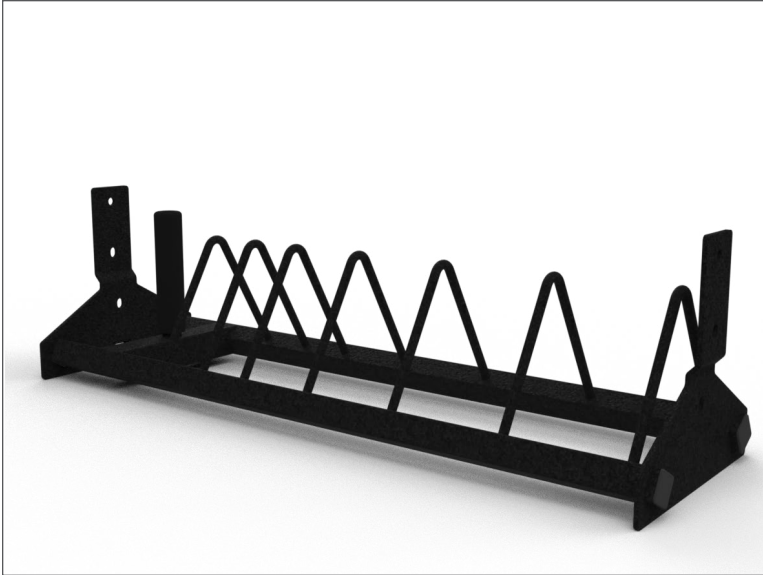

**Product Code:** XCREATE-4BBS

#### DESCRIPTION

- Maximizes bumper plate storage
- Holds smaller weights on vertical post and 10lb - 55lb bumper plates in vertical dividers

#### COMPATIBILITY

X-Create	√
X-Rack	√
X-Siege	
TR-1	
TR-2	

### 6 FT (1.8 M) BUMPER BOOKSHELF STORAGE

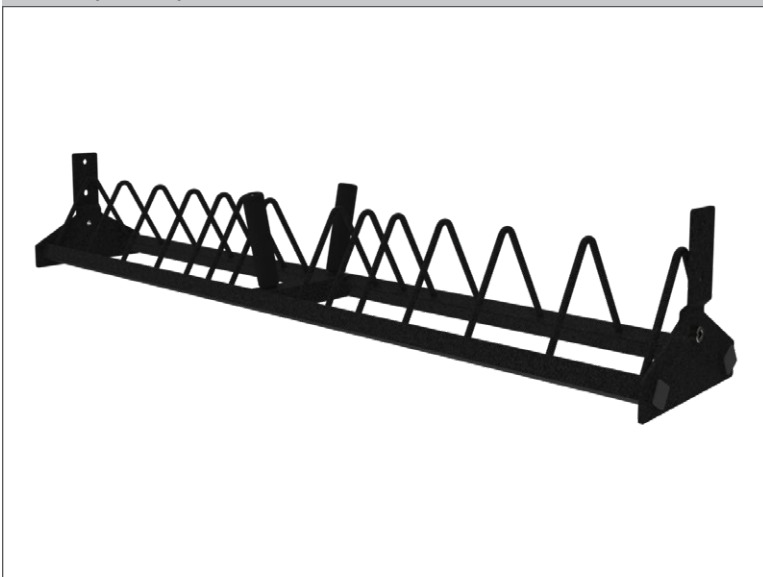

**Product Code:** XCREATE-6BBS

#### DESCRIPTION

- Maximizes bumper plate storage
- Holds smaller weights on vertical post and 10lb - 55lb bumper plates in vertical dividers

#### COMPATIBILITY

X-Create	√
X-Rack	√
X-Siege	
TR-1	√
TR-2	√

## 2025 X-CREATE COMPONENTS

### 4 FT (1.2 M) MONKEY BAR CROSS



**Product Code: XCREATE-4MBX**

#### DESCRIPTION

- 4 foot (1.2 m) rectangular cross used in X-CREATE Bridge configurations
- Combined with the XCREATE-6MBX, allows for bridge span increments of 2 feet (.61 m)
- Textured High Wear Black powder coat finish
- Built in Functional bar

#### COMPATIBILITY

X-Create	√
X-Rack	
X-Siege	
TR-1	
TR-2	

### 6 FT (1.8 M) MONKEY BAR CROSS



**Product Code: XCREATE-6MBX**

#### DESCRIPTION

- 6 foot (1.8 m) rectangular cross used in X-CREATE Bridge configurations
- Combined with the XCREATE-4MBX, allows for bridge span increments of 2 feet (.61 m)
- Textured High Wear Black powder coat finish
- Built in Functional bar

#### COMPATIBILITY

X-Create	√
X-Rack	
X-Siege	
TR-1	
TR-2	

## 2025 X-CREATE COMPONENTS

### 4 FT (1.2 M) MULTI-GRIP CROSS



**Product Code:** XCREATE-4MGX

#### DESCRIPTION

- The X-CREATE Multi-Grip Cross can be substituted for the standard Single Cross on any X-CREATE System
- The fully welded cross includes four ergonomic solid steel 1.25 inch (32 mm) grip locations and a “fat” 2 inch (50 mm) straight bar to develop grip strength

#### COMPATIBILITY

X-Create	√
X-Rack	
X-Siege	
TR-1	
TR-2	

### 4 FT (1.2 M) SINGLE CROSS



**Product Code:** XCREATE-4SX

#### DESCRIPTION

- 1.25 inch diameter pull-up bar featuring “thru-plate” construction
- Textured paint provides sure grip
- Standard cross included with most X-CREATE Base Systems

#### COMPATIBILITY

X-Create	√
X-Rack	
X-Siege	
TR-1	
TR-2	

## 2025 X-CREATE COMPONENTS

### 6 FT (1.8 M) SINGLE CROSS



**Product Code:** XCREATE-6SX

#### DESCRIPTION

- Connects to X-CREATE 8 foot (2.4 m) uprights
- Use with X-CREATE to create 6 feet (1.8 m) spacing between lifting stations in addition to 6 foot trays, universal ball storage, or bumper bookshelf storage.
- Textured paint provides a sure grip

#### COMPATIBILITY

X-Create	√
X-Rack	
X-Siege	
TR-1	
TR-2	

### 2.5 FOOT (0.8 M) SINGLE CROSS



**Product Code:** XCREATE-2.5SX

#### DESCRIPTION

- 1.25 inch diameter pull-up bar featuring “thru-plate” construction
- Use with X-CREATE lifting modules to create 2.5 foot (0.8 m) spacing between storage modules
- Textured paint provides a sure grip

#### COMPATIBILITY

X-Create	√
X-Rack	
X-Siege	
TR-1	
TR-2	

## 2025 X-CREATE COMPONENTS

### BAR SUPPORTS (2 PIECES - PAIR)

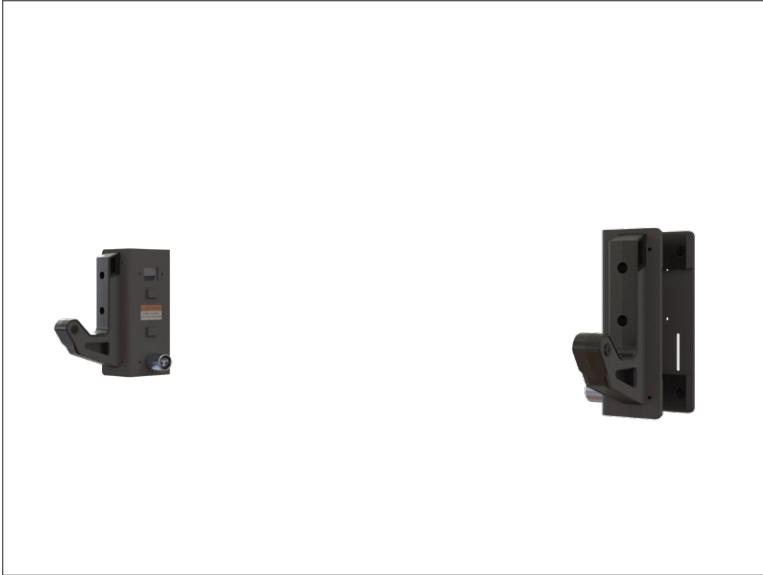

**Product Code: BS**

#### DESCRIPTION

- Included with XCREATE-80LS
- Polyurethane wear guards protect uprights and Olympic Bars
- 850 lb (385 kg) maximum training weight
- Aluminum knob spring pins prevent disengagement with the uprights

#### COMPATIBILITY

X-Create	√
X-Rack	√
X-Siege	√
TR-1	√
TR-2	√

### BAR CATCHES (2 PIECES - PAIR)



**Product Code: BC**

#### DESCRIPTION

- Sold as a pair
- Polyurethane wear guards protect uprights and Olympic Bars
- 850 lb (385 kg) maximum training weight
- Aluminum knob spring pins prevent disengagement with the uprights

#### COMPATIBILITY

X-Create	√
X-Rack	√
X-Siege	√
TR-1	√
TR-2	√

## 2025 X-CREATE COMPONENTS

### DOUBLE PLAY



**Product Code: DP**

### DESCRIPTION

- Attaches to XCREATE-8OLS uprights
- Provides a vertical storage location for Olympic Bars
- Doubles as a battle rope anchor

### COMPATIBILITY

X-Create	√
X-Rack	√
X-Siege	√
TR-1	
TR-2	

### ROCK CLIMBING KIT (2 PIECES-PAIR)



**Product code: XRACK-RCK**

### DESCRIPTION

- Sold as a left and right pair
- Mounts to Monkey Bar Crosses on X-CREATE Bridge Systems to provide rock grip locations
- Textured molded surface provides sure grip

### COMPATIBILITY

X-Create	√
X-Rack	√
X-Siege	√
TR-1	√
TR-2	√

## 2025 X-CREATE COMPONENTS

### 3-DIMENSIONAL SWIVEL WITH MOUNT



**Product Code:** XCREATE-3DSM

#### DESCRIPTION

- Connects to X-CREATE Bridge System Monkey Bar Crosses, 6' Rectangular Crosses and to the X-CREATE Attachment Extension to elevate and extend out heavy bags
- Allows heavy bags to swivel and rotate smoothly on bronze oil impregnated bearings

#### COMPATIBILITY

X-Create	√
X-Rack	√
X-Siege	√
TR-1	
TR-2	

### 3-DIMENSIONAL SWIVEL



**Product Code:** XCREATE-3DS

#### DESCRIPTION

- Connects to X-CREATE 8 foot (2.4 m) uprights and the X-CREATE Top Boom Extension
- Allows heavy bags to swivel and rotate smoothly on bronze oil impregnated bearings
- Note: Only use on uprights that do not have trays attached to them

#### COMPATIBILITY

X-Create	√
X-Rack	
X-Siege	
TR-1	
TR-2	

## 2025 X-CREATE COMPONENTS

### 8 FT (2.4 M) OLYMPIC LIFTING UPRIGHT (2 PCS - PAIR)



**Product Code:** XCREATE-80LU

#### DESCRIPTION

- Heavy gauge 3 inch x 3 inch uprights attach to 8 foot and 2 sided 8 foot pairs of X-CREATE uprights to create a lifting module
- Features laser cut numbered uprights
- Compatible with Bar Supports, Bar Catches, Dip and Plyo Step attachments

#### COMPATIBILITY

X-Create	√
X-Rack	
X-Siege	
TR-1	
TR-2	

### 8 FT (2.4 M) UPIGHT VERTICAL WEIGHT STORAGE (QTY 2)

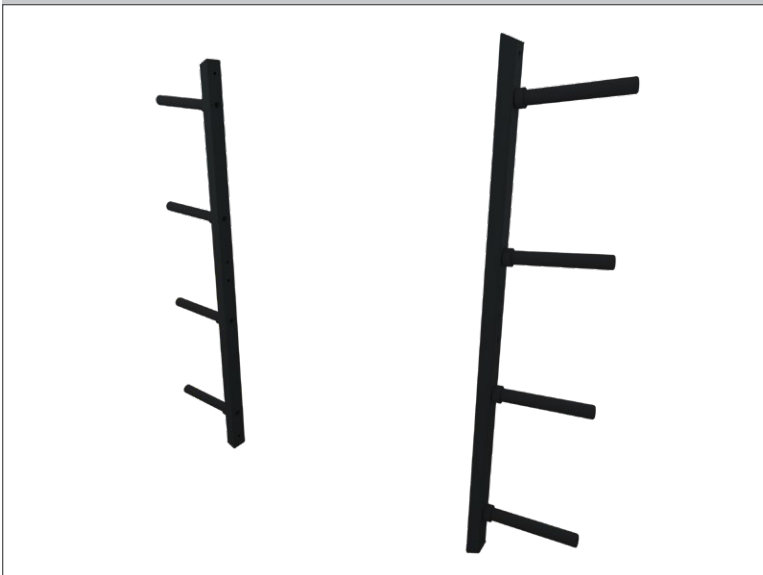

**Product Code:** XCREATE-8UVWS

#### DESCRIPTION

- Mounts to the side of X-CREATE 7 and 8 foot uprights to provide weight storage
- Eight solid steel weight pegs with nylon covers and rubber bumpers protect weight plates
- Each 11.25 inch (286 mm) long peg holds up to 4 Torque 45 lb bumper plates or 6 Torque 45 lb grip plates. Also available as a single (XCREATE-8UVWSS)

#### COMPATIBILITY

X-Create	√
X-Rack	√
X-Siege	
TR-1	
TR-2	

## 2025 X-CREATE COMPONENTS

### 4 FT (1.2 M) SINGLE SIDE HOR. WEIGHT STORAGE



**Product Code: XCREATE-4SSHWS**

#### DESCRIPTION

- Standard as part of the X-CREATE Accessory and Weight Storage Module
- Compatible with any X-CREATE System
- Mounts between uprights and includes two nylon covered solid steel weight horns that are 11.25 inches (285 mm) long

#### COMPATIBILITY

X-Create	√
X-Rack	√
X-Siege	
TR-1	
TR-2	

### 4 FT (1.2 M) STALL BARS



**Product Code: XCREATE-4SB**

#### DESCRIPTION

- (12) 1.25 inch (32 mm) diameter rungs for targeted stretching, body weight and resistance training
- Textured High Wear Black powder coat paint provides a sure grip
- Compatible with XCREATE-DA and XCREATE-4BTWP

#### COMPATIBILITY

X-Create	√
X-Rack	√
X-Siege	
TR-1	
TR-2	

## 2025 X-CREATE COMPONENTS

### 4 FT (1.2 M) BALL TARGET WALL PAD



**Product Code:** XCREATE-4BTWP

#### DESCRIPTION

- Adjustable and removable
- Heavy duty vinyl covered foam pad equipped with sound dampening hooks
- Attaches to XCREATE-4SB (up to qty 3 per side)

#### COMPATIBILITY

X-Create	√
X-Rack	√
X-Siege	
TR-1	
TR-2	

### BALL & HANGING STORAGE EXTENSION



**Product Code:** XCREATE-BHSE

#### DESCRIPTION

- Add more storage to the ends of X-CREATE Systems
- Sized to hold a stability ball of any diameter
- Adjustable pegs allow storage of hanging mats, resistance bands, handles and more

#### COMPATIBILITY

X-Create	√
X-Rack	√
X-Siege	
TR-1	
TR-2	

## 2025 X-CREATE COMPONENTS

### VERTICAL DUMBBELL STORAGE - 4 PAIR



**Product Code:** XCREATE-VDS4

#### DESCRIPTION

- Attaches to both standard and 2-sided X-CREATE 5 foot - 8 foot uprights to either an empty module, a ball and hanging storage module, or to the end of uprights on a system
- Holds four pairs of any size up to 55lb dumbbells
- Includes protective nylon edge protectors

#### COMPATIBILITY

X-Create	√
X-Rack	√
X-Siege	
TR-1	
TR-2	

### VERTICAL DUMBBELL STORAGE - 5 PAIR



**Product Code:** XCREATE-VDS5

#### DESCRIPTION

- Attaches to both standard and 2-sided X-CREATE 5 foot - 8 foot uprights to either an empty module, a ball and hanging storage module, or to the end of uprights on a system
- Holds five pairs of any size up to 30lb dumbbells
- Includes protective nylon edge protectors

#### COMPATIBILITY

X-Create	√
X-Rack	√
X-Siege	
TR-1	
TR-2	

## 2025 X-CREATE COMPONENTS

### BALL TARGET



**Product Code: XCREATE-BT**

#### DESCRIPTION

- Upper Wall Ball Target attaches to boom ends of X-CREATE 8 foot (2.4 m) uprights and provides both a 9 foot (2.7 m) and 10 foot (3.0 m) target height

#### COMPATIBILITY

X-Create	√
X-Rack	
X-Siege	
TR-1	
TR-2	

### BRIDGE BALL TARGET



**Product Code: XCREATE-BBT**

#### DESCRIPTION

- Attaches to X-CREATE Bridge or 6 foot Rectangular Cross
- Provides both a 9 foot (2.7 m) and 10 foot (3.0 m) target height
- Welded, rigid construction with durable, textured powder coat

#### COMPATIBILITY

X-Create	√
X-Rack	√
X-Siege	
TR-1	
TR-2	

## 2025 X-CREATE COMPONENTS

### DOUBLE PLAY - BAR & PLATE STORAGE



**Product Code:** XCREATE-DP

#### DESCRIPTION

- Attaches to X-CREATE upright base to provide storage for Olympic Bars and weight plates up to 16.5 inches (42 cm) in diameter (Fits most 25lb weight plates)
- Solid weight horn shaft is covered with molded nylon cover and bumper to protect weight plates

#### COMPATIBILITY

X-Create	√
X-Rack	
X-Siege	
TR-1	
TR-2	

### MONKEY BAR CROSS EXTENSION (QTY 2)



**Product Code:** XCREATE-MBXE

#### DESCRIPTION

- Links X-CREATE uprights to Monkey Bar Crosses in X-CREATE Bridge Systems
- Textured High Wear Black powder coat paint
- Sold as 2 pieces - pair

#### COMPATIBILITY

X-Create	√
X-Rack	
X-Siege	
TR-1	
TR-2	

## 2025 X-CREATE COMPONENTS

### DIP STEP ANCHOR (2 PIECES – PAIR)



**Product Code: XDSA**

#### DESCRIPTION

- Interlocks with lifting uprights for adjustable height dip movements
- Also can be used as a step-up to reach pull-up or monkey bars
- Gussets have openings to be used with resistance band for adjustable height anchors

#### COMPATIBILITY

X-Create	√
X-Rack	√
X-Siege	√
TR-1	√
TR-2	√

### RELENTLESS ROPE TRAINER



**Product Code: XERT**

#### DESCRIPTION

- Relentless Rope features a variable resistance magnet brake with four difficulty settings
- Included brackets allow for mounting to almost all Torque systems
- Can be used with the X-CREATE Side Attachment Mount, Single Unit Wedge and Double Unit Wedge for additional mounting options

#### COMPATIBILITY

X-Create	√
X-Rack	√
X-Siege	√
TR-1	√
TR-2	√

## 2025 X-CREATE COMPONENTS

### 4 FT (1.2 M) MONITOR MOUNT

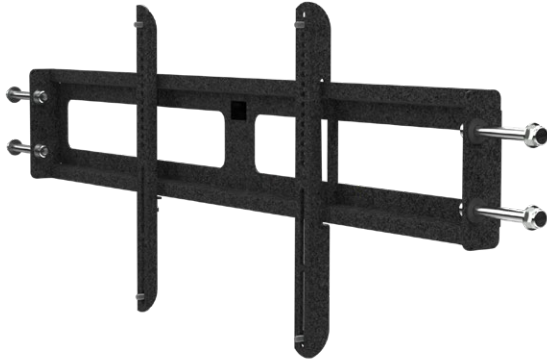

**Product Code:** XCREATE-4MM

#### DESCRIPTION

- Attaches to any X-CREATE 4 foot (1.2 m) module space
- Compatible with flat screen monitors up to 43 inches
- Standard VESA mount

#### COMPATIBILITY

X-Create	√
X-Rack	√
X-Siege	
TR-1	
TR-2	

### ATTACHMENT ANCHOR



**Product Code:** XCREATE-AA

#### DESCRIPTION

- Required with XCREATE-AAD and XCREATE-AAPS
- Mounts to X-CREATE 5 foot - 8 foot uprights for use with the Dip and Plyo Step attachments
- Machined chrome plated pegs keep attachments secure and easy to attach and remove

#### COMPATIBILITY

X-Create	√
X-Rack	√
X-Siege	
TR-1	
TR-2	

## 2025 X-CREATE COMPONENTS

### PLYO-STEP ATTACHMENT



**Product Code:** XCREATE-AAPS

#### DESCRIPTION

- Used in conjunction with the XCREATE-AA Attachment Anchor
- The open design lends itself to visually guiding the attachment into place for easy attachments and adjustments
- Includes an integrated handle
- Features vinyl covered foam padding with landing zones

#### COMPATIBILITY

X-Create	√
X-Rack	√
X-Siege	
TR-1	
TR-2	

### ATTACHMENT ANCHOR DIP



**Product code:** XCREATE-AAD

#### DESCRIPTION

- Used in conjunction with the XCREATE-AA Attachment Anchor
- The open design lends itself to visually guiding the attachment into place for easy attachments and adjustments
- Includes an integrated handle

#### COMPATIBILITY

X-Create	√
X-Rack	√
X-Siege	
TR-1	
TR-2	

## 2025 X-CREATE COMPONENTS

### BATTLE ROPE ANCHOR



**Product Code:** XRACK-BRA

#### DESCRIPTION

- Glass-reinforced molded nylon anchor includes rounded edges to prevent wear on ropes
- Molded-in steel inserts in mounting holes
- Mounts to base of uprights on most X-Series Systems

#### COMPATIBILITY

X-Create	√
X-Rack	√
X-Siege	√
TR-1	√
TR-2	√

### HANGING STORAGE HOOK

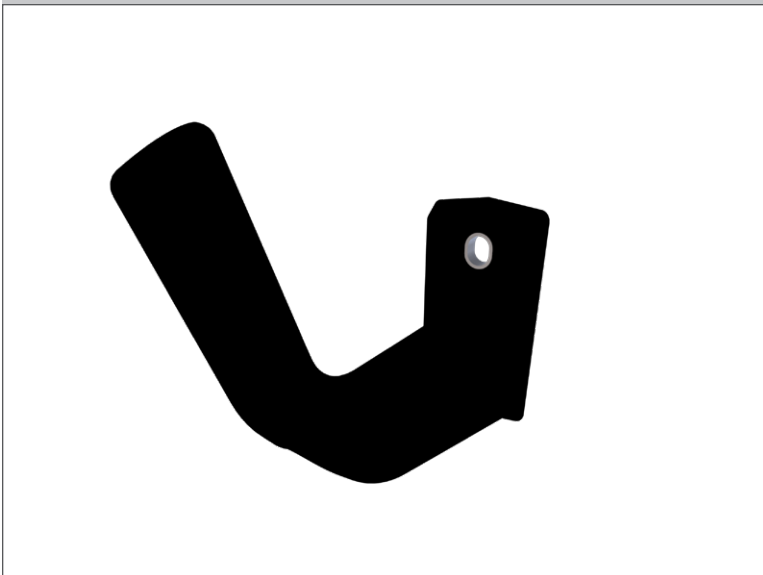

**Product Code:** XCREATE-HSH

#### DESCRIPTION

- Large 8.5 inch (21.6 cm) long nylon molded hook stores battle ropes or other hanging accessories
- Compatible with all X-CREATE systems as well as X-RACK and X-SIEGE systems that have Accessory or Weight Storage uprights
- Pairs well with the XRACK-BRA battle rope anchor

#### COMPATIBILITY

X-Create	√
X-Rack	√
X-Siege	√
TR-1	
TR-2	

## 2025 X-CREATE COMPONENTS

### WEIGHT STORAGE NUMBERING KIT, 5-55 LB



**Product Code:** WSNK5-55

#### DESCRIPTION

- Molded caps snap over weight peg bolts to provide location indicators for weight plates
- Includes CHG PLT, 5, 10, 15, 20, 25, 35, 45 and 55 indicators to include most common sizes of LB or KG weight plates
- Compatible with all X-SERIES products with weight pegs

#### COMPATIBILITY

X-Create	√
X-Rack	√
X-Siege	√
TR-1	√
TR-2	√

### HARDWARE COVER FINISH KIT - 18 BOLT HOLES



**Product Code:** XHCFK-18BH

#### DESCRIPTION

- The Nut Caps serve as a washer replacement and hide exposed bolt threads, protecting accessories from damage
- The Socket Head Cap Screw Covers replace washers and upgrade the aesthetics of your system, giving the X-CREATE a more refined look
- Kit includes 18 Nut and 18 Bolt covers

#### COMPATIBILITY

X-Create	√
X-Rack	√
X-Siege	√
TR-1	√
TR-2	√

## 2025 X-CREATE COMPONENTS

### TOP BOOM EXTENSION



**Product Code:** XCREATE-TBE

#### DESCRIPTION

- Mounts to the top of the X-CREATE 8 foot (2.4 m) uprights to extend pull-up bars further away from accessory trays
- Can also be used to move 3D Swivel further out preventing damage to heavy bags from accessory trays

#### COMPATIBILITY

X-Create	√
X-Rack	
X-Siege	
TR-1	
TR-2	

### BOOM MOUNT, XERT



**Product Code:** XCREATE-BMXERT

#### DESCRIPTION

- Mounts to the top of the XCREATE-8U and XCREATE-2S8U
- Enables the Relentless Rope Trainer and Relentless Ripper to be mounted to the front of an X-CREATE upright

#### COMPATIBILITY

X-Create	√
X-Rack	
X-Siege	
TR-1	
TR-2	

## 2025 X-CREATE COMPONENTS

### HORIZONTAL MOUNT GROUND ROTATIONAL TRAINER



**Product Code:** XHMGRT

#### DESCRIPTION

- Mounts to the base of X-CREATE Uprights, TR1 and TR2 Racks, and to the Lower Band Peg Attachment on X-RACK and X-SIEGE systems.

#### COMPATIBILITY

X-Create	√
X-Rack	√
X-Siege	√
TR-1	√
TR-2	√

### ATTACHMENT EXTENSION



**Product Code:** XCREATE-AE

#### DESCRIPTION

- Mounts to 8 foot and 2-Sided 8 foot uprights to support an elevated 3DSM 3-Dimensional Sivel with mount for Heavy Bag Training
- Textured High Wear Black powder coat paint powder coat finish.

#### COMPATIBILITY

X-Create	√
X-Rack	
X-Siege	
TR-1	
TR-2	

## 2025 X-CREATE COMPONENTS

### VERTICAL BARBELL SIDES - 5 BARBELLS (2 PCS - PAIR)



**Product Code:** XCREATE-VBS5

#### DESCRIPTION

- Mounts to X-CREATE 5 foot, 7 foot and 8 foot uprights to hold 5 straight or EZ curl barbells.
- Includes molded nylon guards to protect barbells and numbered labels.

#### COMPATIBILITY

X-Create	√
X-Rack	
X-Siege	
TR-1	
TR-2	

### VERTICAL BARBELL SIDES - 10 BARBELLS (2 PCS - PAIR)

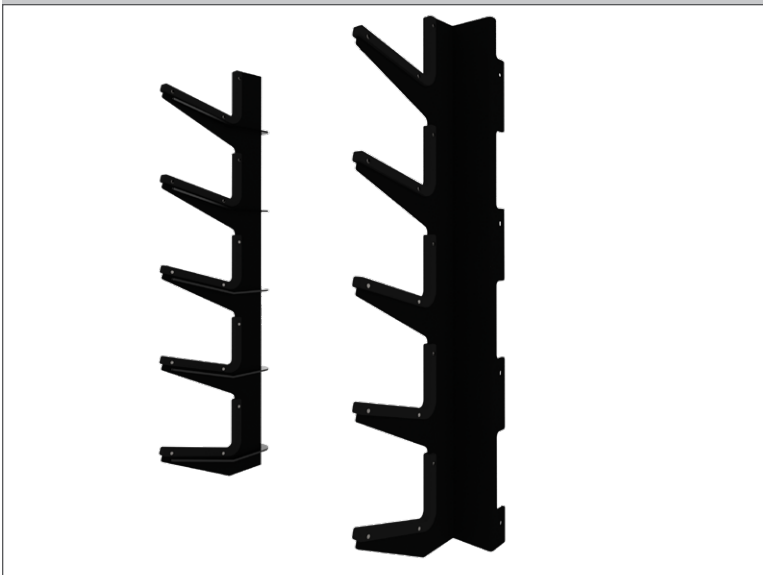

**Product Code:** XCREATE-VBS10

#### DESCRIPTION

- Mounts to X-CREATE 5 foot, 7 foot and 8 foot uprights to hold 10 straight or EZ curl barbells.
- Each pair of hooks hold two barbells.
- Includes molded nylon guards to protect barbells and numbered labels.

#### COMPATIBILITY

X-Create	√
X-Rack	
X-Siege	
TR-1	
TR-2	

## 2025 X-CREATE COMPONENTS

### VERTICAL BARBELL SIDE CONNECTOR (QTY 2)

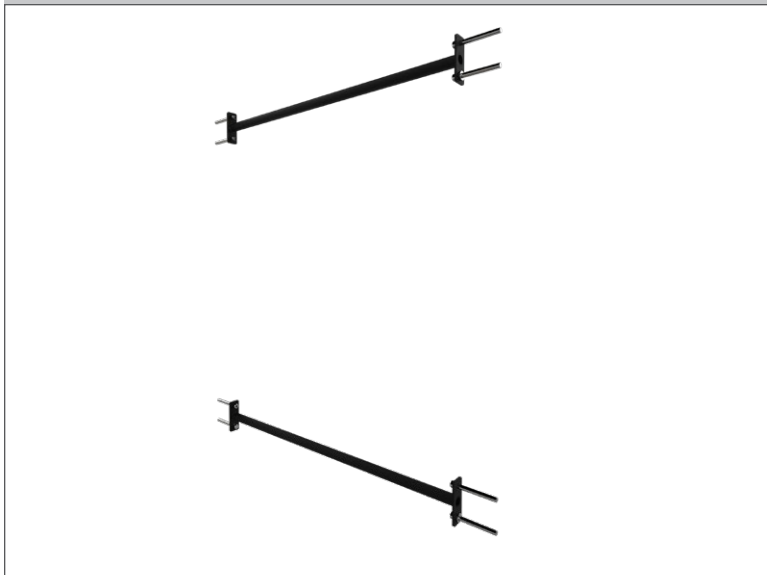

**Product Code:** XCREATE-VBSC

#### DESCRIPTION

- Mounts between the 5 foot uprights of barbell racks or between any X-CREATE uprights to add stability.
- Textured High Wear Black powder coat paint powder coat finish.

#### COMPATIBILITY

X-Create	√
X-Rack	
X-Siege	
TR-1	
TR-2	

### 4 FT (1.2 M) WALL ANCHOR BRACKETS



**Product Code:** XCREATE-4WAB

#### DESCRIPTION

- Used to secure X-CREATE uprights to the wall rather than stabilizing by anchoring to the floor
- Can be fixed to wood studs with included hardware
- Compatible with 7 & 8 foot X-CREATE uprights

#### COMPATIBILITY

X-Create	√
X-Rack	
X-Siege	
TR-1	
TR-2	

## 2025 X-CREATE COMPONENTS

### CABLE STATION WALL MOUNT

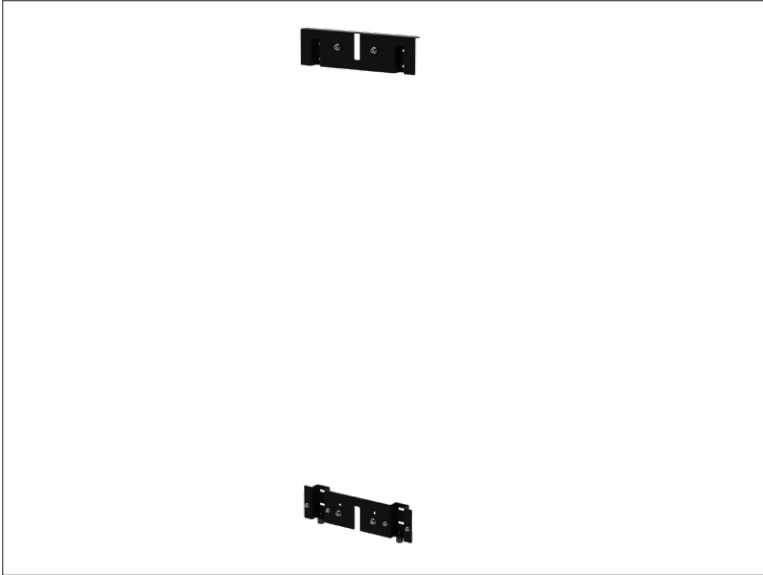

**Product Code:** XCREATE-CSWM

#### DESCRIPTION

- Brackets for anchoring the X-CREATE Cable Column, Seated Row and Lat Pulldown to a wall
- Includes top and bottom bracket
- Included with Wall Mount Packages
- Anchoring hardware is not included

#### COMPATIBILITY

X-Create	√
X-Rack	
X-Siege	
TR-1	
TR-2	

### 4 FT (1.2 M) CABLE STATION CROSS

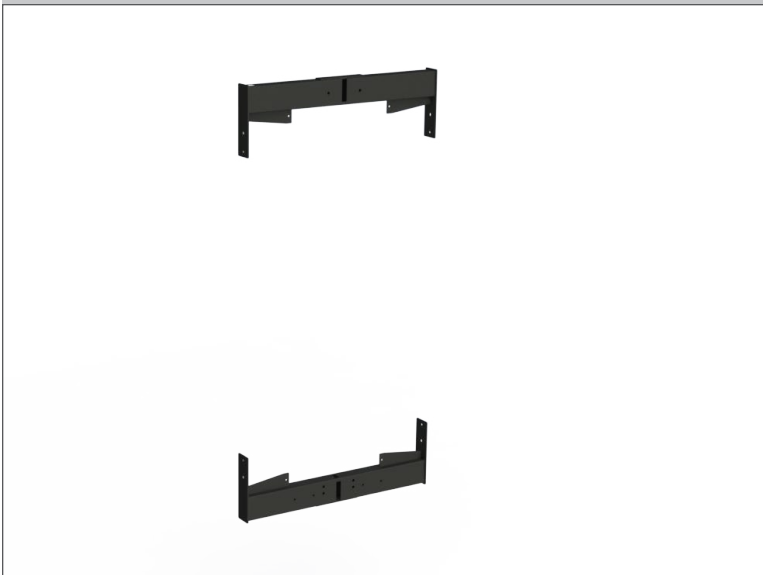

**Product Code:** XCREATE-4CSX

#### DESCRIPTION

- Includes top and bottom cross members for attaching the X-CREATE Cable Column, Seated Row, and Lat Pulldown frames to a module space.
- Included with modules.
- If cable stations are orientated back to back in a module space, they share one of these components.

#### COMPATIBILITY

X-Create	√
X-Rack	√
X-Siege	
TR-1	
TR-2	

## 2025 X-CREATE COMPONENTS

### CABLE STATION TOP CAP



**Product Code:** XCREATE-CSTC

#### DESCRIPTION

- Injection molded top cap for the X-CREATE Cable Column, Seated Row, and Lat Pulldown Modules and Wall mounts.
- Included with all X-CREATE Cable Stations.

#### COMPATIBILITY

X-Create	√
X-Rack	√
X-Siege	
TR-1	
TR-2	

### CABLE STATION SHROUD - FRONT (2 PIECES - PAIR)



**Product Code:** XCREATE-CSSF

#### DESCRIPTION

- Front shroud pair for the X-CREATE Cable Column, Seated Row, and Lat Pulldown Modules and Wall mounts.
- Included with modules.
- Placards are included with the individual station frames and are attached after assembly.

#### COMPATIBILITY

X-Create	√
X-Rack	√
X-Siege	
TR-1	
TR-2	

## 2025 X-CREATE COMPONENTS

### CABLE COMPONENT

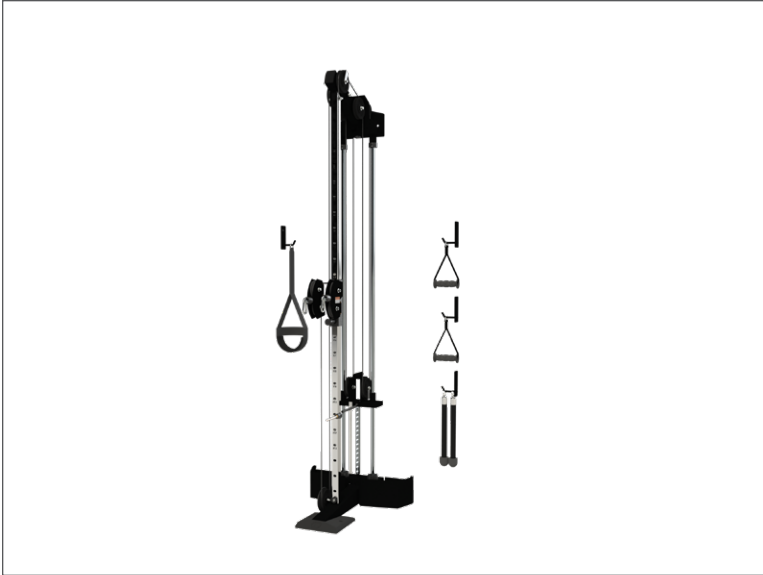

**Product Code: XCREATE-CC**

### DESCRIPTION

- Frame assembly for the X-CREATE Cable Column Module and Wall Mount.
- Includes headplate, cable and accessories.

### COMPATIBILITY

X-Create	√
X-Rack	√
X-Siege	
TR-1	
TR-2	

### LAT PULL DOWN



**Product Code: XCREATE-LPD**

### DESCRIPTION

- Frame assembly for the X-CREATE Lat Pulldown Module and Wall Mount.
- Includes black pads, headplate, cable and aluminum lat bar.
- Adjustable knee hold-down.

### COMPATIBILITY

X-Create	√
X-Rack	√
X-Siege	
TR-1	
TR-2	

## 2025 X-CREATE COMPONENTS

### SEATED ROW



**Product Code: XCREATE-SR**

#### DESCRIPTION

- Frame assembly for the X-CREATE Seated Row Module and Wall Mount.
- Includes black pad, headplate, cable and aluminum low row handle.
- Urethane molded foot placements and frame protector.

#### COMPATIBILITY

X-Create	√
X-Rack	√
X-Siege	
TR-1	
TR-2	

### CABLE STATION SHROUD - REAR

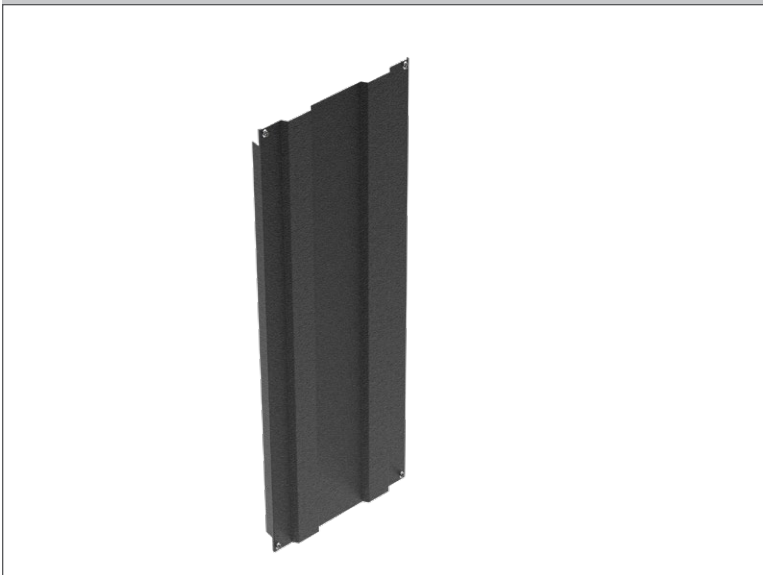

**Product Code: XCREATE-CSSR**

#### DESCRIPTION

- Rear shroud option for X-CREATE Cable Column, Lat Pulldown and Seated Row Modules.
- Recommended for Two-sided X-CREATE with cable stations only on one side or for X-CREATE Wall Systems that are not placed along a wall.

#### COMPATIBILITY

X-Create	√
X-Rack	√
X-Siege	
TR-1	
TR-2	

## 2025 X-CREATE COMPONENTS

### 8 FT (2.4 M) UPRIGHT VERTICAL WEIGHT STORAGE, SINGLE

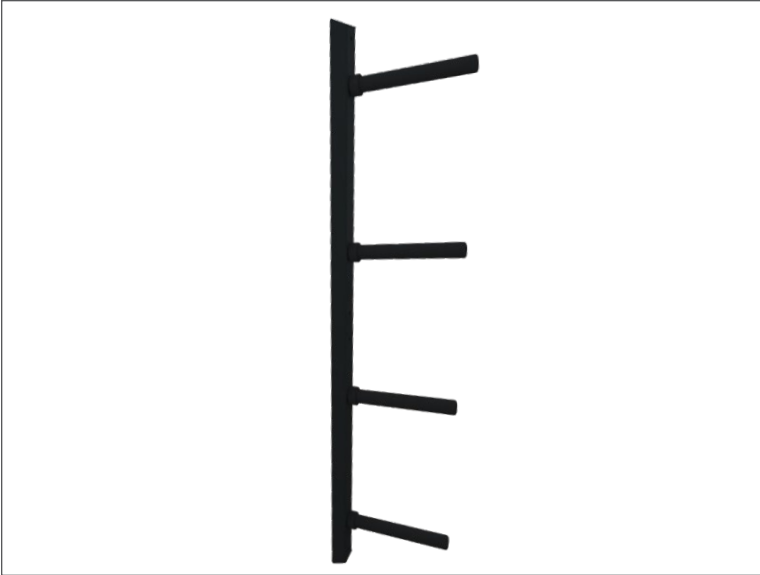

**Product Code:** XCREATE-8UVWSS

#### DESCRIPTION

- Mounts to the side of X-CREATE 8 foot standard and 2-sided uprights to provide weight storage.
- Four solid steel weight pegs with nylon covers and rubber bumpers protect weight plates.
- Each 11.25 in (286 mm) long peg holds up to 4 Torque 45 lb bumper plates or 6 Torque 45 lb grip plates.

#### COMPATIBILITY

X-Create	√
X-Rack	√
X-Siege	
TR-1	
TR-2	

### RESISTANCE BAND ANCHOR

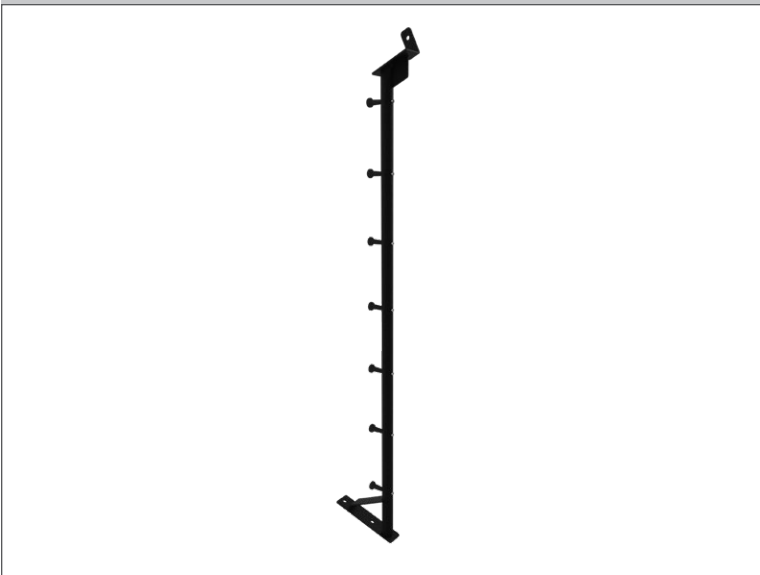

**Product Code:** XCREATE-RBA

#### DESCRIPTION

- Attaches to both standard and 2-Sided 8 foot (2.4 M) X-CREATE uprights. Sold individually.
- Allows for use of power bands, rope training and battle ropes.
- Storm grey powder coat paint with molded nylon pegs.

#### COMPATIBILITY

X-Create	√
X-Rack	
X-Siege	
TR-1	
TR-2	

## 2025 X-CREATE COMPONENTS

### UPRIGHT LOWER CROSS BRACE (2 PIECES-PAIR)



**Product Code:** XCREATE-ULCB

#### DESCRIPTION

- Sold as a pair, the Upright Lower Cross Brace can be attached to the end uprights to add lateral stability to any X-CREATE Wall or 2-Sided Center System.
- Creates a single or double heavy bag station when combined with an X-CREATE upright and a 3D Swivel.

#### COMPATIBILITY

X-Create	√
X-Rack	
X-Siege	
TR-1	
TR-2	

### WEIGHT STACK PLATES - 10 LB x 5

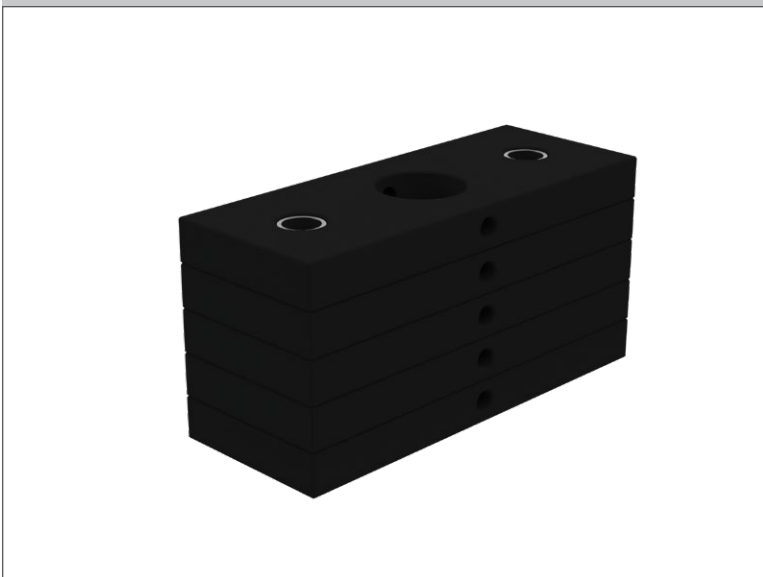

**Product Code:** WSP10-5

#### DESCRIPTION

- Box of five 10 lb powdercoated steel weight plates with bushings
- Used with Cable Column Stations, Seated Row, and Lat Pulldown

#### COMPATIBILITY

X-Create	√
X-Rack	√
X-Siege	√
TR-1	
TR-2	

## 2025 X-CREATE COMPONENTS

### WEIGHT STACK PLATES - 15 LB x 5



**Product Code:** WSP15-5

#### DESCRIPTION

- Box of five 15 lb powdercoated steel weight plates with bushings
- Used with Cable Column Stations, Seated Row, and Lat Pulldown

#### COMPATIBILITY

X-Create	√
X-Rack	√
X-Siege	√
TR-1	
TR-2	

### WEIGHT STACK PLATES - 20 LB x 5

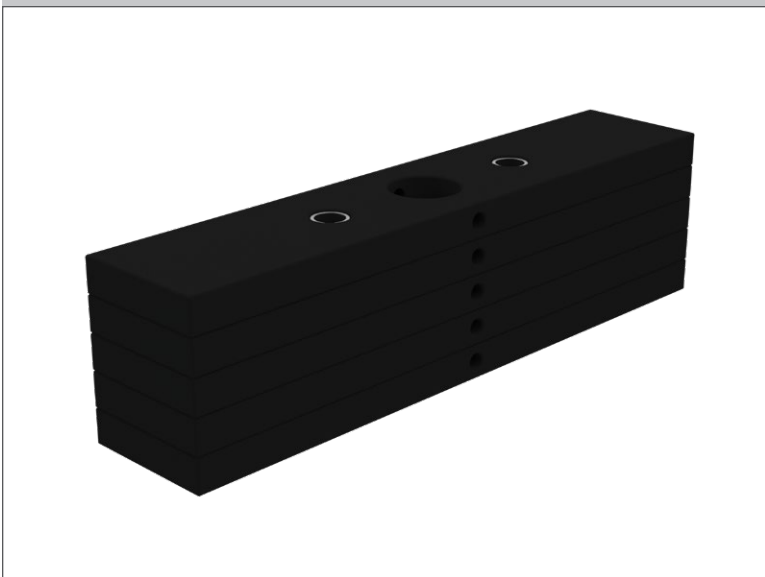

**Product Code:** WSP20-5

#### DESCRIPTION

- Box of five 20 lb powdercoated steel weight plates with bushings
- Used with Cable Column Stations, Seated Row, and Lat Pulldown

#### COMPATIBILITY

X-Create	√
X-Rack	√
X-Siege	√
TR-1	
TR-2	

## 2025 X-CREATE COMPONENTS

### BALL & HANGING STORAGE



**Product Code:** XCREATE-4BHS

#### DESCRIPTION

- Rails designed to accommodate different diameter balls
- Adjustable curved pegs provide storage for exercise mats with holes spaced 15 in - 21.7 in (38 cm - 55 cm)
- Additional pegs to store various hanging accessories

#### COMPATIBILITY

X-Create	√
X-Rack	√
X-Siege	
TR-1	
TR-2	

### 4 FOOT (1.2 M) COUNTERWEIGHT SUPPORT



**Product Code:** XCREATE-4CWS-8U

#### DESCRIPTION

- A way to alleviate floor anchoring and is engineered with plates and supports to off-set the system, preventing tipping and rocking when used in certain X-CREATE modules
- Requires outriggers
- Compatible with X-CREATE 7U and 8U uprights

#### COMPATIBILITY

X-Create	√
X-Rack	
X-Siege	
TR-1	
TR-2	

## 2025 X-CREATE COMPONENTS

### 4 FOOT (1.2 M) MONKEY BAR



**Product Code:** XCREATE-4MB

#### DESCRIPTION

- Used on X-CREATE bridge units to create Monkey Bar spans
- Textured paint provides a sure grip

#### COMPATIBILITY

X-Create	√
X-Rack	
X-Siege	
TR-1	
TR-2	

### 6 FOOT (1.8 M) COUNTERWEIGHT SUPPORT

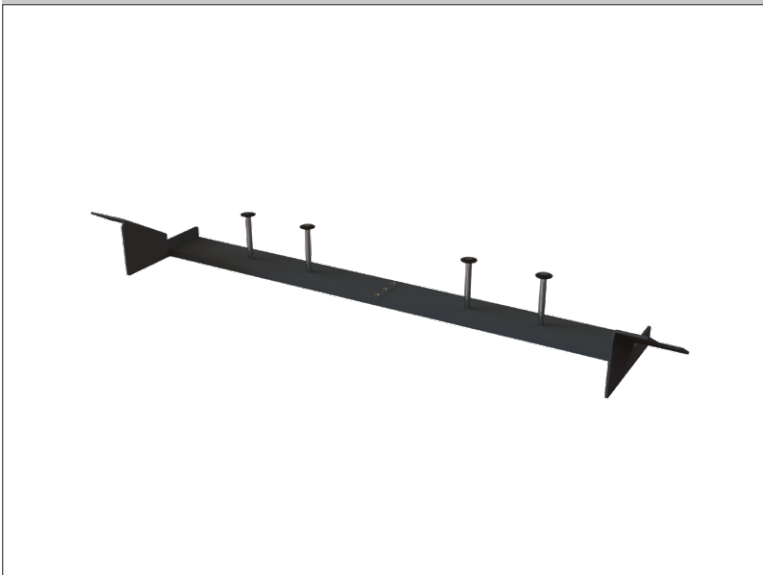

**Product Code:** XCREATE-6CWS-8U

#### DESCRIPTION

- A way to alleviate floor anchoring and is engineered with plates and supports to off-set the system, preventing tipping and rocking when used in certain X-CREATE modules
- Requires outriggers
- Compatible with X-CREATE 7U and 8U uprights

#### COMPATIBILITY

X-Create	√
X-Rack	
X-Siege	
TR-1	
TR-2	

## 2025 X-CREATE COMPONENTS

### 6 FOOT (1.8 M) FUNCTIONAL BAR



**Product Code:** XCREATE-6FB

#### DESCRIPTION

- Mounts to bottom of X-CREATE 6 foot (1.8 m) monkey bar crosses
- Provides pull-up stations or anchors for suspension training straps

#### COMPATIBILITY

X-Create	√
X-Rack	
X-Siege	
TR-1	
TR-2	

### CABLE STATION CORNER CROSS

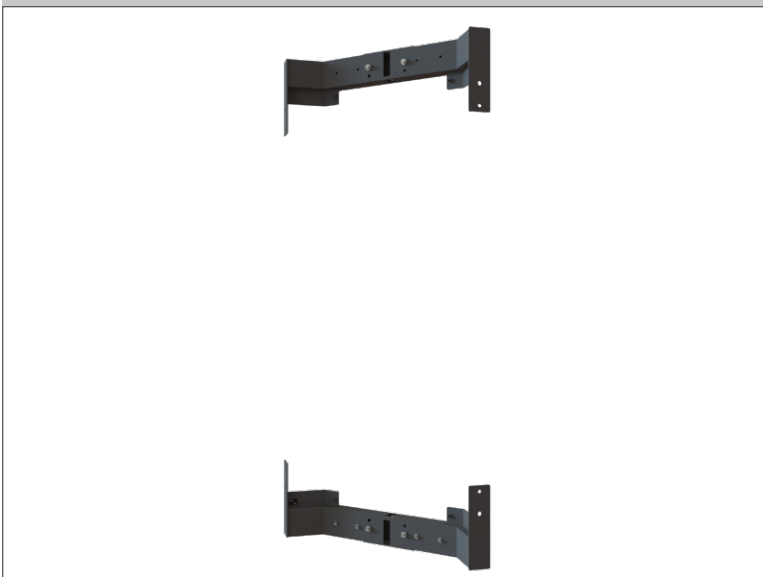

**Product Code:** XCREATE-CSCX

#### DESCRIPTION

- Used with X-CREATE Corner Storage Cable Package to attach cable station to uprights

#### COMPATIBILITY

X-Create	√
X-Rack	
X-Siege	
TR-1	
TR-2	

## 2025 X-CREATE COMPONENTS

### COUNTERWEIGHT PLATE - 50 LB



**Product Code:** XCREATE-CWP-50

#### DESCRIPTION

- For use with X-CREATE Counterbalance Attachment
- Prevents tipping and rocking on systems that are not anchored to the floor

#### COMPATIBILITY

X-Create	√
X-Rack	
X-Siege	
TR-1	
TR-2	

### HOOK, MAGNETIC SUSPENSION CLIP (QTY 2)

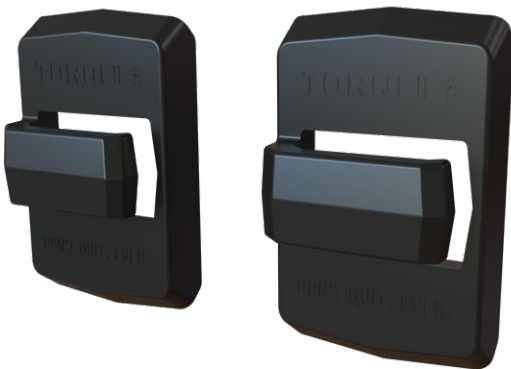

**Product Code:** XCREATE-HMSC

#### DESCRIPTION

- Attaches to any 3 inch (75 mm) wide tube with magnets and is used to capture and retain suspension straps when not in use

#### COMPATIBILITY

X-Create	√
X-Rack	√
X-Siege	√
TR-1	√
TR-2	√

## 2025 X-CREATE COMPONENTS

### OUTRIGGER - 1.5 FT (0.5 M)



**Product Code:** XCREATE-OR-1.5

#### DESCRIPTION

- 1.5 foot (0.5 m) outrigger attachments help prevent systems from rocking or tipping during use
- Includes a welded loop for battle ropes

#### COMPATIBILITY

X-Create	√
X-Rack	
X-Siege	
TR-1	
TR-2	

### STORAGE ATTACHMENT, BOSU (2 PIECES)



**Product Code:** XCREATE-SA-BOSU-2

#### DESCRIPTION

- Every box includes 2 BOSU Storage Attachment brackets that can be assembled on the same or different X-CREATE uprights
- Holds one BOSU per piece

#### COMPATIBILITY

X-Create	√
X-Rack	√
X-Siege	
TR-1	
TR-2	

## 2025 X-CREATE COMPONENTS

### 6 FOOT (1.8 M) RECTANGULAR CROSS



**Product Code:** XCREATE-6RX

#### DESCRIPTION

- Includes mounting holes for various attachments
- Constructed with 3x3 inch 11 gauge steel with gussets

#### COMPATIBILITY

X-Create	√
X-Rack	
X-Siege	
TR-1	
TR-2	

### 2.5 FOOT (0.8 M) BALL & HANGING STORAGE



**Product Code:** XCREATE-2.5BHS

#### DESCRIPTION

- Rails designed to accommodate different diameter balls
- Adjustable curved pegs provide hanging storage for exercise mats, bands, power tubes, and more
- Used adjacent to lifting modules to maximize storage space

#### COMPATIBILITY

X-Create	√
X-Rack	√
X-Siege	
TR-1	
TR-2	

## 2025 X-CREATE COMPONENTS

### CHANGE PLATE WEIGHT HORN (QTY 2)

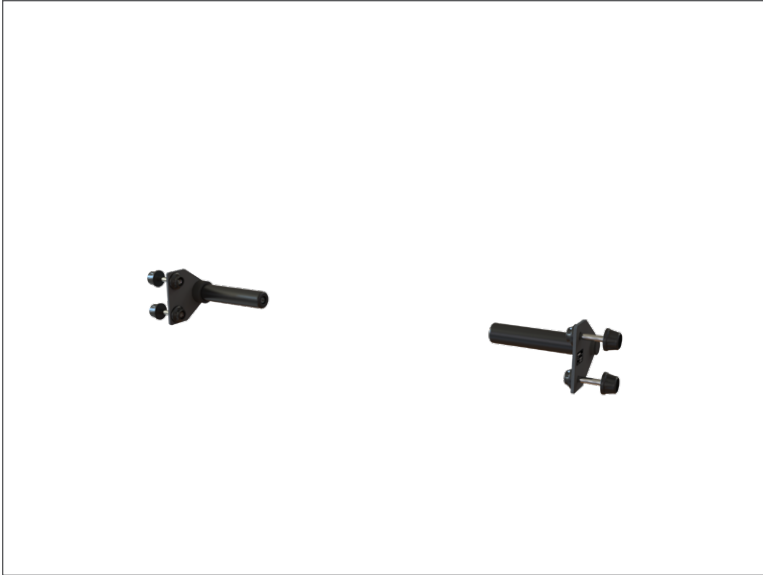

**Product Code:** CPWH

#### DESCRIPTION

- Mounts to X-CREATE, X-RACK and X-SIEGE uprights
- Four steel weight pegs with nylon covers and rubber bumpers protect weight plates

#### COMPATIBILITY

X-Create	√
X-Rack	√
X-Siege	√
TR-1	
TR-2	

### SIDE ATTACHMENT MOUNT



**Product Code:** XCREATE-SAM

#### DESCRIPTION

- Attaches to side of X-CREATE uprights
- Creates an additional mounting point for Relentless Ripper or Relentless Rope

#### COMPATIBILITY

X-Create	√
X-Rack	
X-Siege	
TR-1	
TR-2	

## 2025 X-CREATE COMPONENTS

### SINGLE UNIT WEDGE



**Product Code:** XCREATE-SUW

### DESCRIPTION

- For use with X-CREATE Side Attachment Mount
- Slotted for effortless attachment of Relentless Rope or Relentless Ripper
- Angles the Relentless Rope or Ripper 25 degrees in either direction to create space for users against a wall

### COMPATIBILITY

X-Create	√
X-Rack	
X-Siege	
TR-1	
TR-2	

### DOUBLE UNIT WEDGE



**Product Code:** XCREATE-DUW

### DESCRIPTION

- For use with X-CREATE Side Attachment Mount
- Slotted for effortless attachment of Relentless Rope or Relentless Ripper
- Allows for two units to be mounted to the end of an X-CREATE Double Sided Upright

### COMPATIBILITY

X-Create	√
X-Rack	
X-Siege	
TR-1	
TR-2	

## 2025 X-CREATE COMPONENTS

### 4 FT (1.2M) OFFSET STALL BAR (QTY 2)



**Product Code:** XCREATE-40SB

#### DESCRIPTION

- Attaches to the backside of X-SELECT modules, with or without shrouds
- Compatible with Ball Target Wall Pad and Stall Bar Dip Attachment

#### COMPATIBILITY

X-Create	√
X-Rack	√
X-Siege	
TR-1	
TR-2	

### STALL BAR DIP ATTACHMENT



**Product Code:** XCREATE-SBDA

#### DESCRIPTION

- Easily attaches to X-CREATE Stall Bars
- Features 2 inch diameter powder coated, angled handles for various grip widths
- Holds up to 300lbs

#### COMPATIBILITY

X-Create	√
X-Rack	√
X-Siege	
TR-1	
TR-2	

## 2025 X-CREATE COMPONENTS

### FOAM ROLLER STORAGE



**Product Code:** XCREATE-FRS6-8

#### DESCRIPTION

- Mounts to the side of X-CREATE uprights
- Holds qty 8 foam rollers up to 6 inches in diameter

#### COMPATIBILITY

X-Create	√
X-Rack	√
X-Siege	
TR-1	
TR-2	

### 8 FT (2.4 M) SADDLE DUMBBELL RACK TIER



**Product Code:** XCREATE-8SDRT

#### DESCRIPTION

- Compatible with all X-CREATE uprights to add storage for Pro-Style dumbbells
- Holds up to 5 pairs of dumbbells per tray

#### COMPATIBILITY

X-Create	√
X-Rack	
X-Siege	
TR-1	
TR-2	

## 2025 X-CREATE COMPONENTS

### 4 FT (1.2 M) CUSTOM SIGN BRACKET



**Product Code:** XCREATE-4CSB-CL

#### DESCRIPTION

- Add any company name, logo, or tagline with a custom graphic decal to the Custom Sign Bracket
- Includes holes for pegs to utilize space below for hanging storage

#### COMPATIBILITY

X-Create	√
X-Rack	√
X-Siege	
TR-1	
TR-2	

### 4 FT (1.2 M) HIP THRUST CABLE STATION CROSS

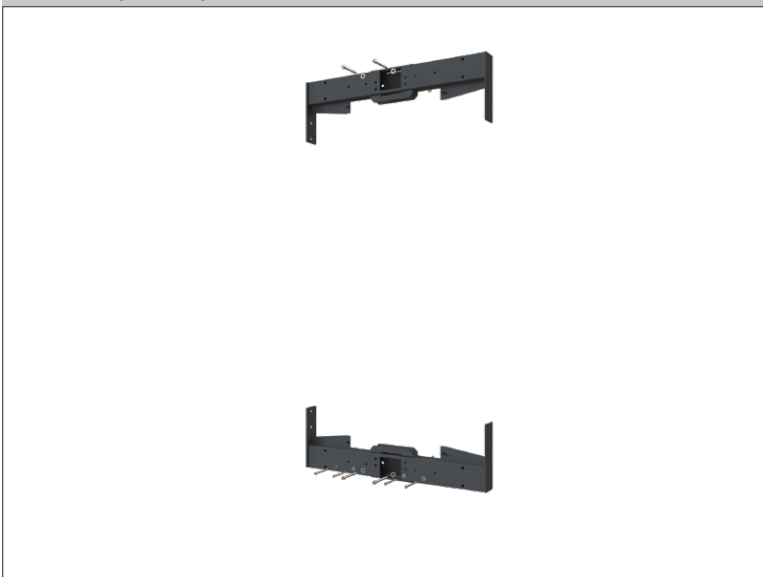

**Product Code:** XCREATE-HTCSX

#### DESCRIPTION

- Includes top and bottom cross members for attaching the X-CREATE Hip Thrust frame to a module space
- Included with module
- If cable stations are orientated back to back in a module space, they share one of these components

#### COMPATIBILITY

X-Create	√
X-Rack	√
X-Siege	
TR-1	
TR-2	

## 2025 X-CREATE COMPONENTS

### HIP THRUST CABLE STATION WALL MOUNT

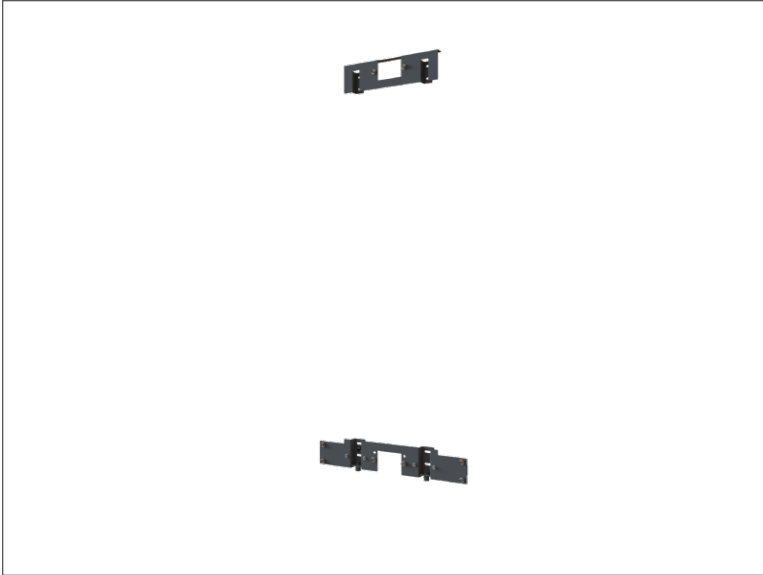

**Product Code:** XCREATE-HTCSWM

#### DESCRIPTION

- Brackets for anchoring the X-CREATE Hip Thrust to a wall
- Includes top and bottom bracket
- Included with Wall Mount Packages
- Anchoring hardware is not included

#### COMPATIBILITY

X-Create	√
X-Rack	
X-Siege	
TR-1	
TR-2	

### BAR CATCH STORAGE ATTACHMENT (QTY 2)

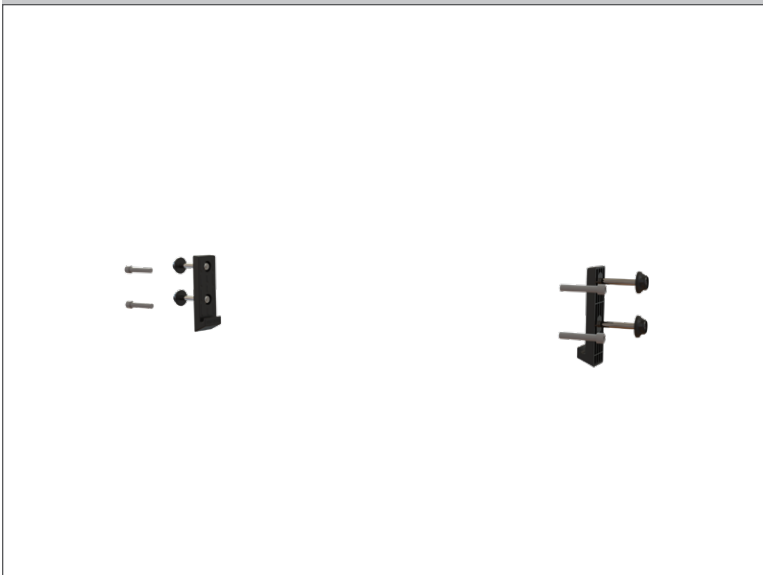

**Product Code:** BCSA

#### DESCRIPTION

- Stows Bar Catches on uprights when not in use
- Standard on TR-2 Series racks

#### COMPATIBILITY

X-Create	√
X-Rack	√
X-Siege	√
TR-1	√
TR-2	√

## 2025 X-CREATE COMPONENTS

### CORNER STALL BAR (QTY 2)



**Product Code:** XCREATE-CSB

#### DESCRIPTION

- (12) 1.25 inch (32mm) diameter rungs for targeted stretching, body weight and resistance training
- Textured High Wear Black powder coat paint provides a sure grip
- For use on X-CREATE Corner Systems

#### COMPATIBILITY

X-Create	√
X-Rack	
X-Siege	
TR-1	
TR-2	

### CORNER PULL-UP CROSS



**Product Code:** XCREATE-CPUX

#### DESCRIPTION

- Includes dimpled solid steel multi-grips for pull-up and chin-up variety as well as rock grips
- Additional attachments such as XERT, XRR-SKI, and XCREATE-BBT can be mounted

#### COMPATIBILITY

X-Create	√
X-Rack	
X-Siege	
TR-1	
TR-2	

## 2025 X-CREATE COMPONENTS

### SKIER, RELENTLESS RIPPER



**Product Code: XRR-SKI**

#### DESCRIPTION

- Features 10 levels of progressive magnetic resistance
- Included brackets allow for mounting to almost all Torque systems
- Console tracks time, strokes per minute, watts, calories, distance, and more.

#### COMPATIBILITY

X-Create	√
X-Rack	√
X-Siege	√
TR-1	√
TR-2	√

### SQUAT HANDLE ATTACHMENT



**Product Code: XSHA**

#### DESCRIPTION

- Features 6" handles with rubber grips
- Has a large, 2" diameter for comfort and stability when safety squatting

#### COMPATIBILITY

X-Create	√
X-Rack	√
X-Siege	√
TR-1	√
TR-2	√

## 2025 X-CREATE COMPONENTS

### HIP THRUST (BOX 1/2)



**Product Code:** XCREATE-HT-101

#### DESCRIPTION

- Includes the seat, back pads, lap belt, hardware, assembly instructions and placards
- XCREATE-HT-201 required to make a complete unit

#### COMPATIBILITY

X-Create	√
X-Rack	√
X-Siege	
TR-1	
TR-2	

### HIP THRUST (BOX 2/2)



**Product Code:** XCREATE-HT-201

#### DESCRIPTION

- Includes head plate, top boom, support tubes and base
- XCREATE-HT-101 required to make a complete unit

#### COMPATIBILITY

X-Create	√
X-Rack	√
X-Siege	
TR-1	
TR-2	

## 2025 X-CREATE COMPONENTS

### BACK EXTENSION (BOX 1/2)



**Product Code:** XCREATE-BE-101

#### DESCRIPTION

- Contains main frame, footplates, and linear guide rod adjustment system
- Urethane molded foot plate covers provide a firm grip during use
- Requires XCREATE-BE-201 to complete unit

#### COMPATIBILITY

X-Create	√
X-Rack	√
X-Siege	
TR-1	
TR-2	

### BACK EXTENSION (BOX 2/2)



**Product Code:** XCREATE-BE-201

#### DESCRIPTION

- Contains seat adjustment, pads and hardware
- Includes a multi-grip handle with swivel
- High density pads for comfort and durability
- Requires XCREATE-BE-101 to complete unit

#### COMPATIBILITY

X-Create	√
X-Rack	√
X-Siege	
TR-1	
TR-2	

## 2025 X-CREATE COMPONENTS

### STANDING HIP ABDUCTOR (BOX 1/2)



**Product Code: XCREATE-SHA-101**

#### DESCRIPTION

- Includes base and handle mount weldments, as well as instructions, artwork and hardware required for assembly
- XCREATE-SHA-201 required to complete unit

#### COMPATIBILITY

X-Create	√
X-Rack	√
X-Siege	
TR-1	
TR-2	

### STANDING HIP ABDUCTOR (BOX 2/2)

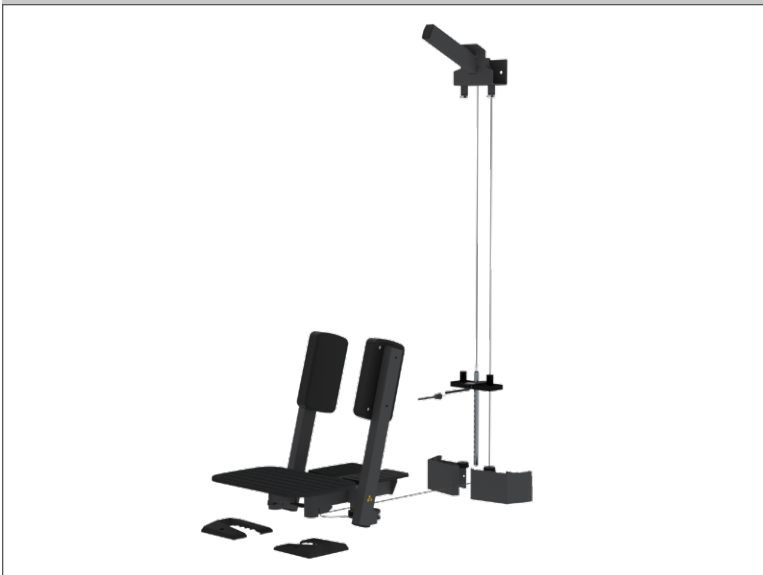

**Product Code: XCREATE-SHA-201**

#### DESCRIPTION

- Includes movement arms, pads, foot plate, top boom and cable assemblies
- XCREATE-SHA-101 required to complete unit

#### COMPATIBILITY

X-Create	√
X-Rack	√
X-Siege	
TR-1	
TR-2	

## 2025 X-CREATE COMPONENTS

### UPRIGHT CABLE COMPONENT



**Product Code:** XCREATE-UCC

#### DESCRIPTION

- Included with XCREATE-U-8SSCC, XCREATE-U-8DSCC, and XCDAP

#### COMPATIBILITY

X-Create	√
X-Rack	
X-Siege	
TR-1	
TR-2	

### UPRIGHT CABLE COLUMN SHROUDS - OPEN



**Product Code:** XCREATE-UCCSO

#### DESCRIPTION

- ABS shrouds included with XCREATE-U-8SSCC, XCREATE-U-8DSCC, and XCDAP

#### COMPATIBILITY

X-Create	√
X-Rack	
X-Siege	
TR-1	
TR-2	

## 2025 X-CREATE COMPONENTS

### X-CREATE CORNER DAP FRAME

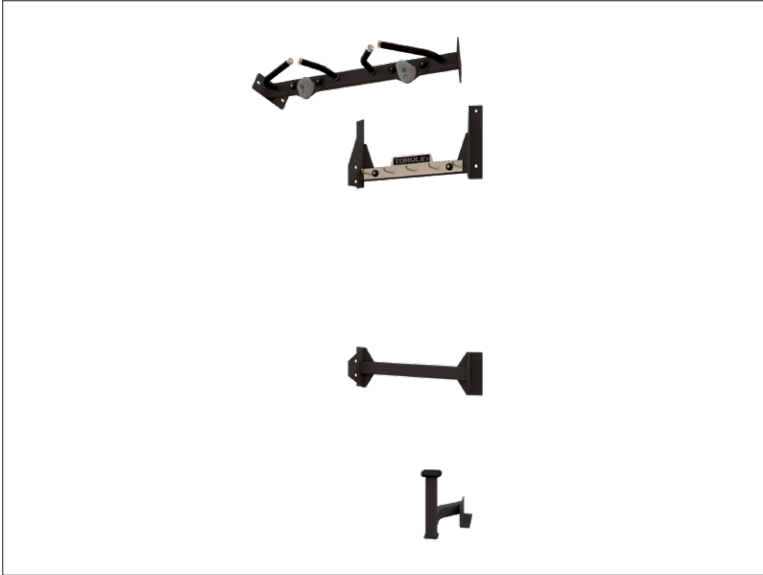

**Product Code:** XCREATE-CDAPF

#### DESCRIPTION

- Frame and pull-up cross components for use with Dual Adjustable Pulley (DAP)

#### COMPATIBILITY

X-Create	√
X-Rack	
X-Siege	
TR-1	
TR-2	

### UPRIGHT CABLE COLUMN SHROUDS - CLOSED

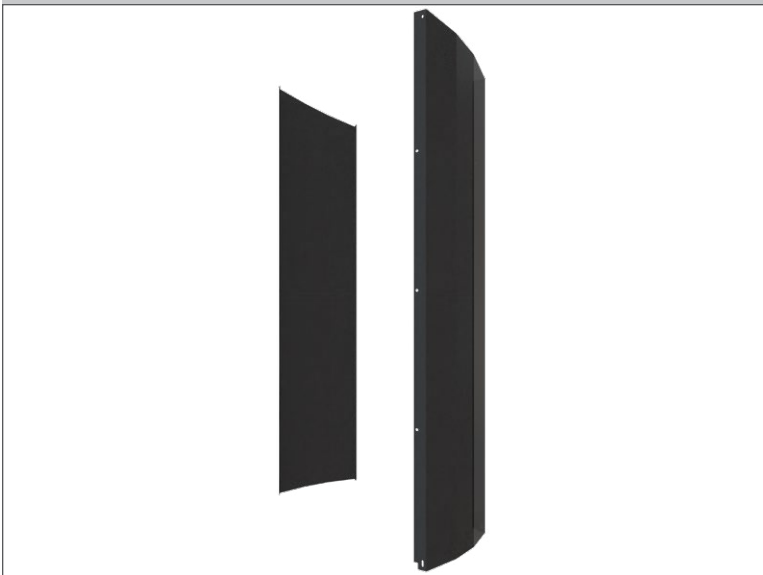

**Product Code:** XCREATE-UCCSC

#### DESCRIPTION

- Tinted ABS shrouds for backside of Dual Adjustable Pulley (DAP)

#### COMPATIBILITY

X-Create	√
X-Rack	
X-Siege	
TR-1	
TR-2	

## 2025 X-CREATE COMPONENTS

### 8 FT (2.4 M) UPRIGHT DOUBLE SIDED CABLE COMPONENT HARDWARE KIT

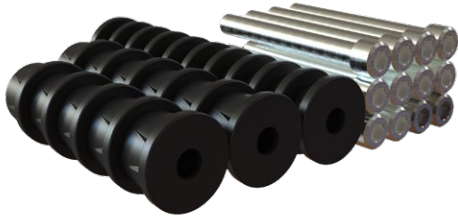

**Product Code:** XCREATE-U-8DSCCHK

#### DESCRIPTION

- Hardware kit included with Dual Adjustable Pulley (DAP)

#### COMPATIBILITY

X-Create	√
X-Rack	
X-Siege	
TR-1	
TR-2	

### UNIVERSAL BALL STORAGE HANGING PEGS (QTY 6)



**Product Code:** XCREATE-UBSHP6

#### DESCRIPTION

- Hanging storage pegs mountable to the XCREATE-4CSB to create a hanging storage module
- Supports hanging mats, straps and bands. Horizontally adjustable for mats with varying hole widths
- 16mm diameter with grooves to retain mats. Includes nuts to attach

#### COMPATIBILITY

X-Create	√
X-Rack	√
X-Siege	√
TR-1	
TR-2	

## 2025 X-CREATE COMPONENTS

### BELT SQUAT, X-RACK



**Product Code:** XRACK-BSQUAT

#### DESCRIPTION

- Belt squat attachment that bolts to the base of Torque Rigs and Racks
- Folding kickstand has a magnetic latch to ensure it is out of the way during exercise
- Starting weight of 30 lbs (13.6 kg)
- Belt, chain, hook, and carabiner included

#### COMPATIBILITY

X-Create	√
X-Rack	√
X-Siege	√
TR-1	
TR-2	

### BELT SQUAT ANGLE BRACKET



**Product Code:** XCREATE-BSQUATAB

#### DESCRIPTION

- Used to mount XRACK-BSQUAT to X-CREATE uprights
- Angled bracket allows for X-CREATE wall system mounting without wall interference
- Includes hardware

#### COMPATIBILITY

X-Create	√
X-Rack	
X-Siege	
TR-1	
TR-2	

## 2025 X-CREATE COMPONENTS

### GROUND ROTATIONAL TRAINER - X-CREATE



**Product Code:** XCREATE-GRT

#### DESCRIPTION

- Also referred to as a Landmine
- Can be combined with XCREATE-GRTBS or XCREATE-GRTPS to add bar and/or plate storage

#### COMPATIBILITY

X-Create	√
X-Rack	
X-Siege	
TR-1	
TR-2	

### BAR STORAGE, X-CREATE GROUND ROTATIONAL TRAINER



**Product Code:** XCREATE-GRTBS

#### DESCRIPTION

- Vertical barbell storage
- Can be mounted to left or right side of XCREATE-GRT
- Combines with XCREATE-GRT and XCREATE-GRTPS to create the X-CREATE Triple Play

#### COMPATIBILITY

X-Create	√
X-Rack	
X-Siege	
TR-1	
TR-2	

## 2025 X-CREATE COMPONENTS

### PLATE STORAGE, X-CREATE GROUND ROTATIONAL TRAINER



**Product Code:** XCREATE-GRTPS

### DESCRIPTION

- Bumper plate storage
- Mounts to either left or right side of XCREATE-GRT
- Combines with XCREATE-GRT and XCREATE-GRTBS to create the X-CREATE Triple Play

### COMPATIBILITY

X-Create	√
X-Rack	
X-Siege	
TR-1	
TR-2	